

BSS84W-G

P-Channel
RoHS Device

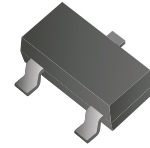

Features

- Low on-resistance.
- Low gate threshold voltage.
- Low input capacitance.
- Fast Switching Speed.

Circuit diagram

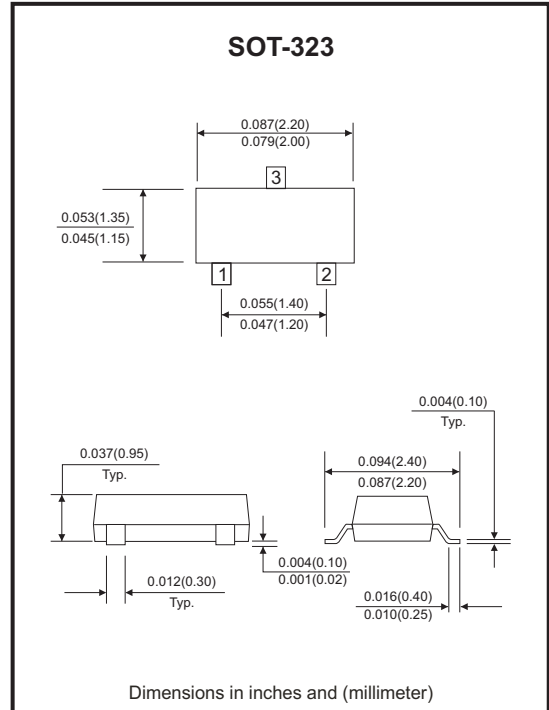
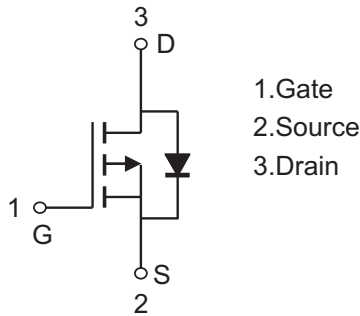

Maximum Ratings and Electrical Characteristics

(at Ta=25 °C unless otherwise noted)

Parameter	Symbol	Value	Units
Drain-Source voltage	V _{DSS}	-50	V
Drain-Gate voltage	V _{DGR}	-50	V
Gate-Source voltage	V _{GSS}	±20	A
Drain current (Note 1)	I _D	-130	mA
Power dissipation (Note 1)	P _D	200	mW
Thermal resistance from junction to ambient	R _{θJA}	625	°C/W
Junction temperature	T _J	150	°C
Storage temperature	T _{STG}	-55 to +150	°C

Note:

1. Device mounted on FR-4 PCB, 1 inch x 0.85 inch x 0.062 inch; pad layout as shown on.

Company reserves the right to improve product design , functions and reliability without notice.

REV: A

Electrical Characteristics (at TA=25°C unless otherwise noted)

Parameter	Symbol	Conditions	Min	Typ	Max	Units
Drain-source breakdown voltage	$V_{(BR)DSS}$	$V_{GS}=0V, I_D=-250\mu A$	-50	-75	-	V
Gate threshold voltage	$V_{GS(th)}$	$V_{DS}=V_{GS}, I_D=-1mA$	-0.8	-1.6	-2.0	V
Gate-body leakage current	I_{GSS}	$V_{DS}=0V, V_{GS}=\pm 20V$	-	-	± 100	nA
Zero gate voltage drain current	I_{DSS}	$V_{DS}=-50V, V_{GS}=0V, T_J=25^\circ C$	-	-	-15	μA
		$V_{DS}=-50V, V_{GS}=0V, T_J=125^\circ C$	-	-	-60	
		$V_{DS}=-25V, V_{GS}=0V, T_J=25^\circ C$	-	-	-100	
Forward transconductance	g_{FS}	$V_{DS}=-25V, I_D=100mA$	50	-	-	mS
Static drain-source on-resistance	$R_{DS(on)}$	$V_{GS}=-5V, I_D=100mA$	-	6	10	Ω
Input capacitance	C_{iss}	$V_{DS}=-25V, V_{GS}=0V, f=1.0MHz$	-	-	45	μF
Output capacitance	C_{oss}		-	-	25	
Reverse transfer capacitance	C_{rss}		-	-	12	
Turn-on delay time	$t_{d(on)}$	$V_{DD}=-30V, I_D=-0.27A, V_{GS}=-10V, R_{GEN}=50\Omega$	-	10	-	nS
Turn-off delay time	$t_{d(off)}$		-	18	-	

RATING AND CHARACTERISTIC CURVES (BSS84W-G)

Fig.1 - Max. Power dissipation vs. Ambient Temperature

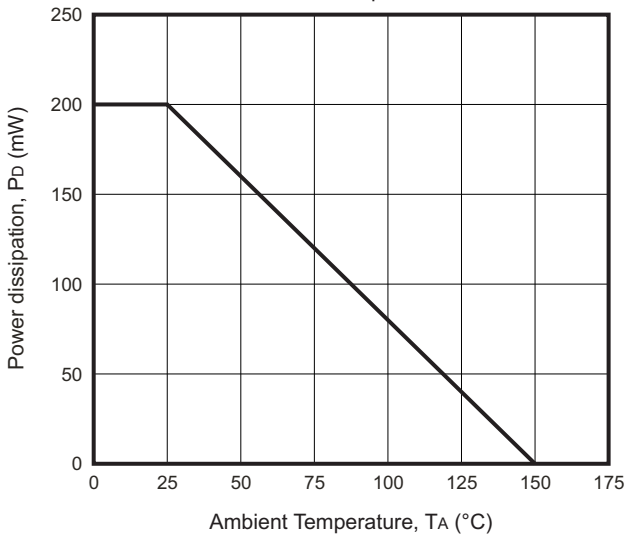

Fig.2 - Drain Source Current vs. Drain Source Voltage

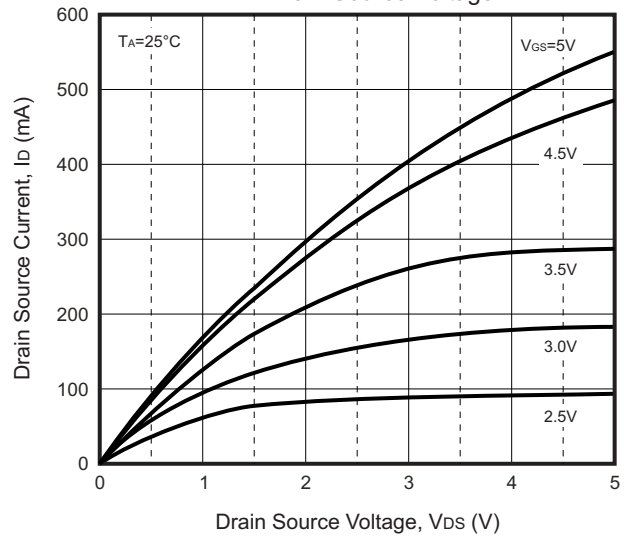

Fig.3 - Drain Current vs. Gate Source Voltage

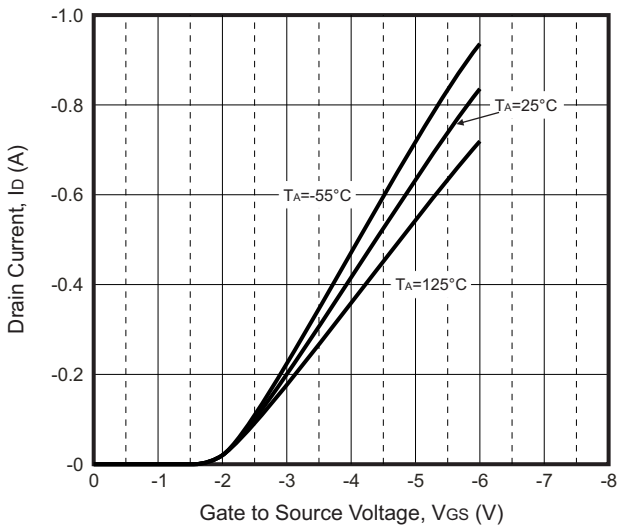

Fig.4 - ON-Resistance vs. Gate Source Voltage

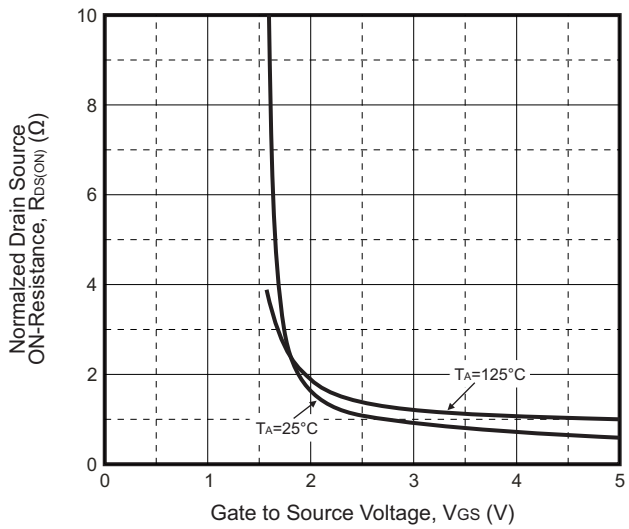

Fig.5 - ON-Resistance vs. Junction Temperature

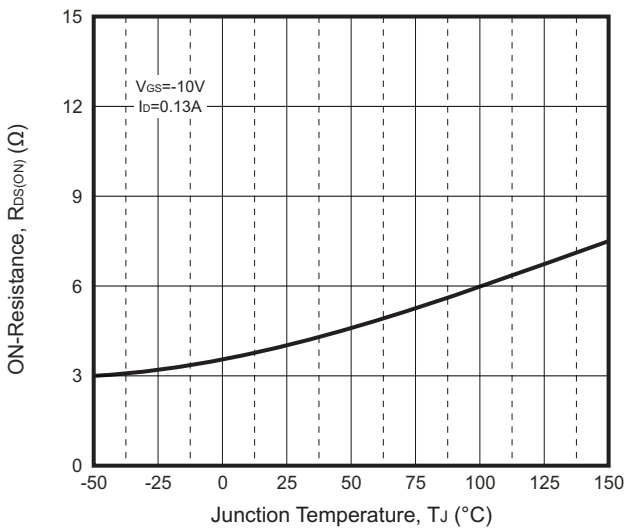
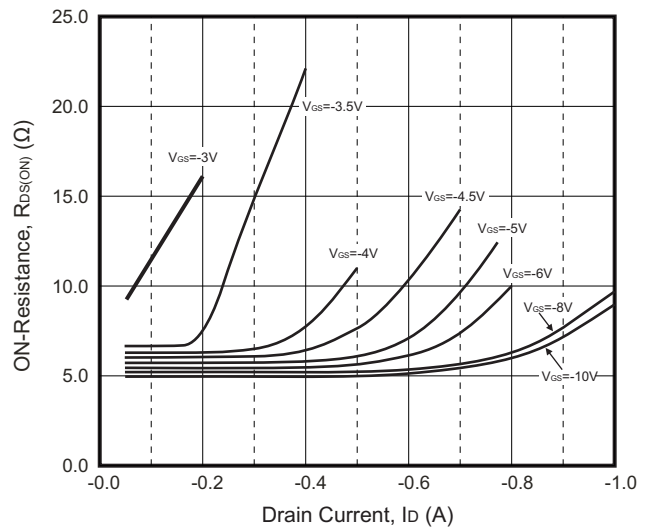

Fig.6 - ON-Resistance vs. Drain Current



Company reserves the right to improve product design, functions and reliability without notice.

REV: A

Reel Taping Specification

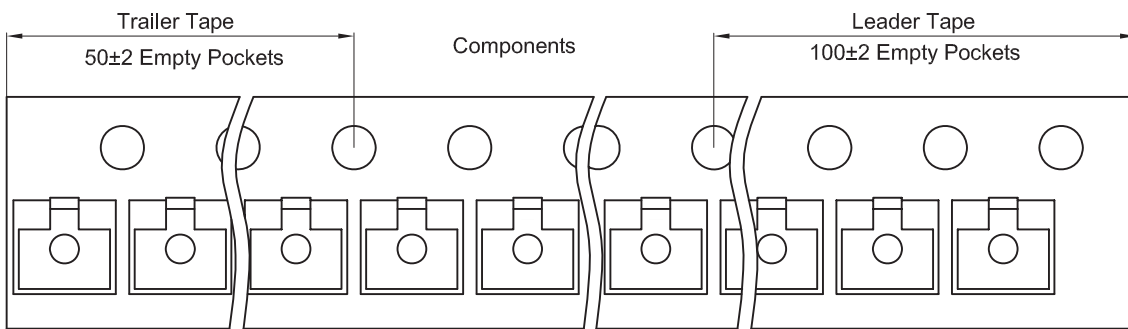
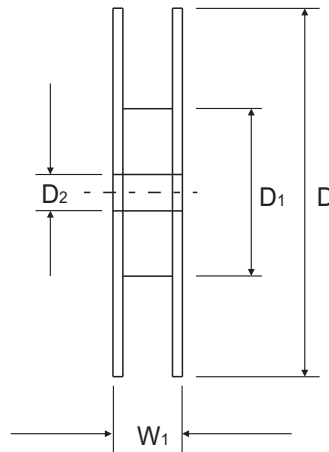
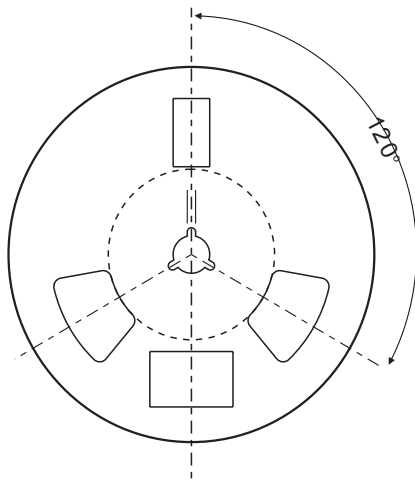
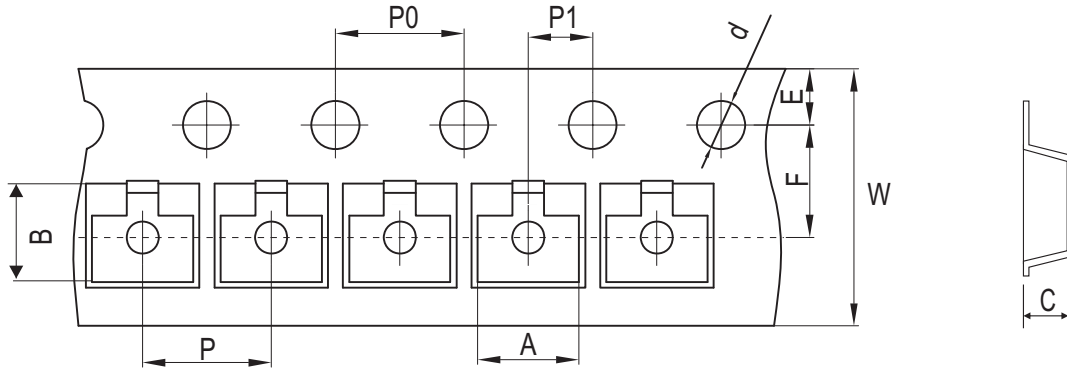

SOT-323	SYMBOL	A	B	C	d	D	D1	D2
	(mm)	2.40 ± 0.10	2.40 ± 0.10	1.20 ± 0.10	1.50 ± 0.10	178.00 ± 1.00	54.40 ± 0.50	13.00 ± 0.50
	(inch)	0.094 ± 0.004	0.094 ± 0.004	0.047 ± 0.004	0.059 ± 0.004	7.087 ± 0.039	2.142 ± 0.020	0.512 ± 0.020

SOT-323	SYMBOL	E	F	P	P0	P1	W	W1
	(mm)	1.75 ± 0.10	3.50 ± 0.05	4.00 ± 0.10	4.00 ± 0.10	2.00 ± 0.05	8.00 + 0.30 / - 0.10	9.50 ± 1.00
	(inch)	0.069 ± 0.004	0.138 ± 0.002	0.157 ± 0.004	0.157 ± 0.004	0.079 ± 0.002	0.315 + 0.012 / - 0.004	0.374 ± 0.039

Company reserves the right to improve product design , functions and reliability without notice.

REV: A

Marking Code

Part Number	Marking Code
BSS84W-G	K84

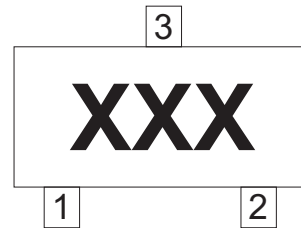

xxx = Product type marking code

Suggested PAD Layout

SIZE	SOT-323	
	(mm)	(inch)
A	0.90	0.035
B	0.70	0.028
C	1.30	0.051
D	1.90	0.075

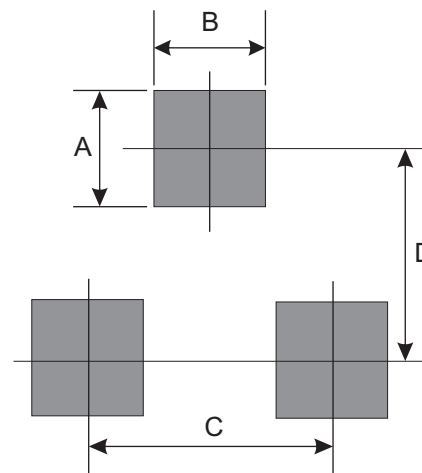

Note:
1. The pad layout is for reference purposes only.

Standard Packaging

Case Type	REEL PACK	
	REEL (pcs)	Reel Size (inch)
SOT-323	3,000	7